

SPX/SPZ **SPARTAN**

High Power Luminaire Range - Installation Guide

Zone 1 and 21 Variant CML 17ATEX1148 & IEC Ex CML17.0074 or CML21UKEX1102

Zone 2 and 22 Variant CML 17ATEX4149 & IEC Ex CML17.0074 or CML21UKEX4101

Zone 21 Dust only Variant CML 18ATEX3161 & IEC Ex CML18.0087 or CML21UKEX3107

This installation guide provides instructions for installing the SPARTAN HP Highbay/ Floodlight series of explosion protected floodlights.

Overview

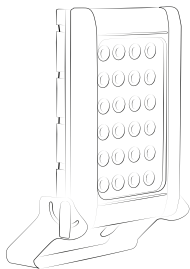

- 1 Safety Instructions
- 2 Installation
- 3 Maintenance
- 4 Technical Specification
- 5 Trouble Shooting

Important information

The SPARTAN HP series of explosion protected floodlights/highbay are specialist devices, certified for use in specific operating environments.

The units must be installed in accordance with these instructions, must be correctly certified for the specific operating environment and must be installed by suitably qualified personnel.

If you have any queries about the installation or the certification of the unit – please contact Raytec for immediate assistance and advice.

1. Safety instructions

1. Read this leaflet carefully before commencing to install the SPARTAN unit and retain it for future use. Installation can only be carried out by suitably qualified personnel.
2. Check the certification to ensure that the Zone, mains supply, ambient temperature present and 'T' rating are suitable for the environment the unit is being installed in.
3. DO NOT open when energised.
4. If the SPARTAN unit is to be installed in areas of high vibration, please consult with Raytec.
5. SPARTAN units are designed to withstand marine environments and are tested in accordance with IEC60068-2-52. However if the SPARTAN unit is to be installed in a very high corrosive environment such as **coastal** and **offshore** the following good practice should be followed:

During installing ensure there are no scratches, chips or defects in external paint surface that would allow ingress of water to bare aluminium. If so touch up with suitable paint

During installation apply an anti corrosive jointing compound to screw threads such as PSU cover and external earth points.

During installation ensure exterior surface of the product is not in direct contact with a dissimilar metal such as galvanised steel. If so fit a nylon barrier to prevent galvanic corrosion.

During maintenance regularly wash down external surface of fitting with clean, fresh water to remove any deposits of mineral salts on the exterior surface.

5. The SPARTAN unit housing is constructed from marine grade aluminium and toughened glass, gaskets are silicone sponge, black encapsulant and o rings are silicone rubber, internally some components are non-metallic. The end user must ensure that these materials are suitable for the environment the SPARTAN unit will be installed in; Zone 1 and Zone 2 Hazardous areas.
6. Check certification nameplate on side of floodlight/highbay to ascertain type of threaded cable entry on the luminaire. Select suitably certified ATEX/IEC Ex /UKEX cable glands and stopper plugs, these must be parallel thread, have a minimum of 5 full thread engagement and be of a medium/fine tolerance to ISO965-1 and ISO965-3. The cable entry devices selected must maintain the IP rating of the luminaire
7. The incoming mains cable should not exceed a temperature rise of 20°C above the ambient conditions; select suitable cable.
8. To ensure the safety of the equipment, ensure that the 'flamepath' on Zone 1 variants are free from any corrosion. No repairs are possible to flameproof joints – if in doubt please consult the manufacturer.
9. External fasteners must have a yield strength of at least 600N/mm²
10. On Zone 1 variants the LED assembly contains no user serviceable parts, the luminaire must not be operated without all the individual LED polycarbonate covers in position, the IP66 rating must be maintained.
11. When the unit is installed correctly and in accordance with these installation instructions it will not harm humans or animals.



Isolate mains before removing cover



Install in a well ventilated area

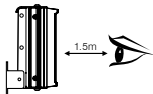

Do not continually stare at lamp

2. Installation

Mounting SPARTAN Unit

1. To meet the requirements of certification a **MINIMUM** of 2 fixing points must be used, the fixing points must be suitable for the conditions of use.
2. The line diagrams below are for guidance only – units may be mounted in any orientation

Mounting HP SPARTAN Unit – Floodlight Application

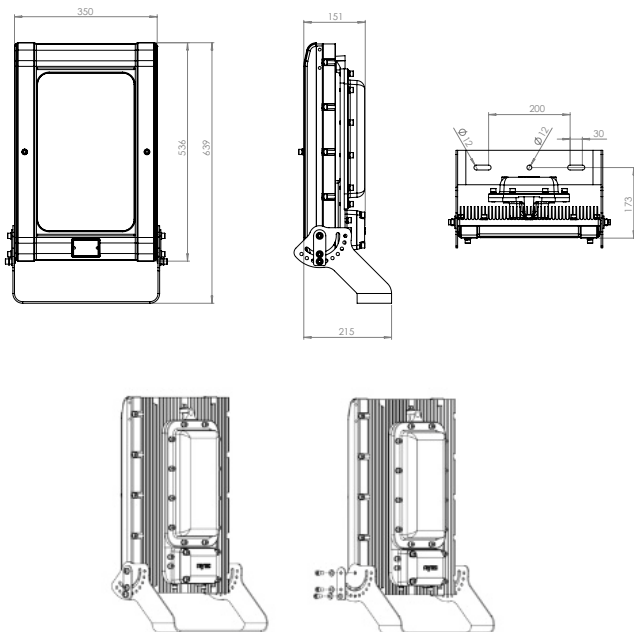

Mounting SPARTAN Unit – Highbay Application

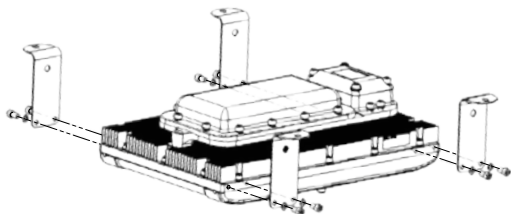
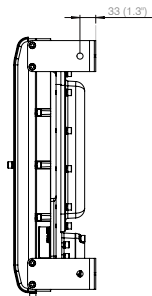
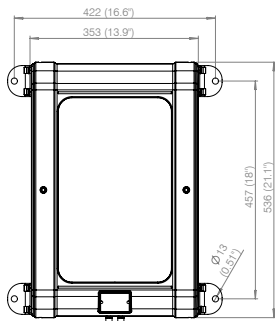
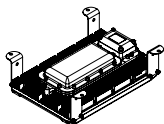
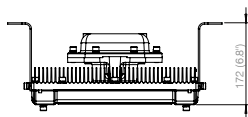

Typical wiring diagram

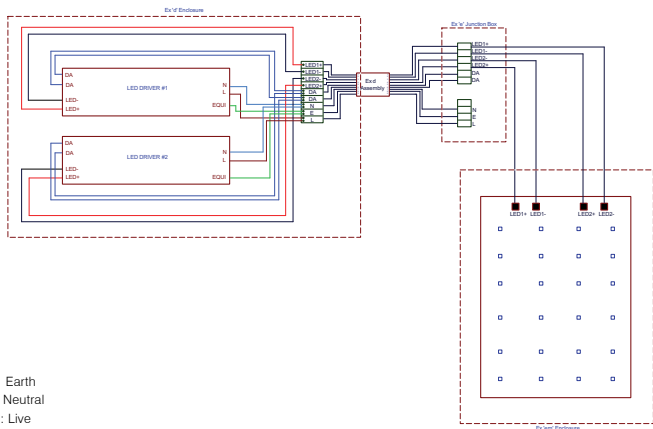

Wire the Mains cable into the terminal block. Provision has been made for this and identified as the E (Earth), L1 (Switched Live), L2 (permanent live) and N (Neutral) terminals. There are two pairs of contacts for each of these to facilitate a mains cable that can be looped in and out of the unit. The L2 terminals on a standard unit are not electrically connected but allows them to be used on the same circuits as *emergency bulkheads*.

3. Open terminal block enclosure
4. Installer should earth the unit separately – an internal and external earth point are provided as standard
5. Connect wires to mains supply.
6. If the unit is opened for any reason, disconnect mains
7. All SPARTAN floodlights/highbay have terminal blocks suitable for looping 4mm² cable, only one cable should be connected to each terminal block connection – when incoming cables are installed a creepage and clearance of 5mm and 4mm respectively.
8. To use DALI/Dimming interface, connect the DALI terminals on the terminal block
9. Ensure no cables are trapped and gasket is seated correctly and replace terminal block cover. Tighten to 4Nm
10. If carrying out Insulation Resistance tests the normal method of insulation testing is to connect Live and Neutral together and test between this point and Earth to prevent the risk of damage to the electronic control gear.

3. Maintenance

1. It is essential that all SPARTAN units are maintained in accordance with the requirements of the EN60079-17 standard: (Electrical apparatus for explosive gas atmospheres – other than mines).
2. **IMPORTANT.** No modifications are permitted to the unit, all spare parts must be purchased from the manufacturer, unauthorized modifications or spare parts will invalidate certification and make the equipment dangerous.
3. Isolate the SPARTAN unit from the mains supply and allow to cool before carrying out any maintenance work.
4. The unit has 2 independent power supplies; in the event that a power supply needs to be replaced remove the flameproof cover to get access to the power supply. Remove the power supply from the mains terminals then remove LED red and black wires. If replacing a power supply on a Zone 2 luminaire the orange silicone gasket should be replaced at the same time to maintain the restricted breathing properties of the enclosure, the gasket is located in the machined groove, all replacement gaskets must be supplied via Raytec
5. Disposal of packaging, SPARTAN units and old LED assemblies/power supplies should be carried out in accordance with national regulations.

PROTECTION/CERTIFICATION

PROTECTION/CERTIFICATION – ZONE 1/21 VARIANTS

CML17ATEX1148 or IEC Ex CML17.0074 or CML21UKEX1102

II 2 GD Ex db eb mb IIB T4 Gb

Ta -50°C to +50°C

Ex tb IIIC T104°C Db

Ta -50°C to +50°C

IP66 150-264V AC/DC or 110-254V AC/DC

PROTECTION/CERTIFICATION – ZONE 2/22 VARIANTS

CML17ATEX4149 or IEC Ex CML17.0074 or CML21UKEX4101

II 3 GD Ex nR ec IIC Gc

Ta -50°C to +50°C

Ex tc IIIC T104°C Dc

Ta -50°C to +50°C

IP66 150-264V AC/DC or 110-254V AC/DC

PROTECTION/CERTIFICATION – ZONE 21 DUST ONLY VARIANTS

CML18ATEX3161 or IEC Ex CML18.0087 or CML21UKEX3107

Ex tb IIIC T104°C Db

Ta -50°C to +50°C

IP66 150-264V AC/DC or 110-254V AC/DC

4. Technical Specification

	120W version	300W version
Input Voltage	150-264V AC/DC or 110-254V AC/DC	
Input Current (230Vac, full load)	0.52A	1.4A
Consumption	120W	300W
Power Factor (230Vac, full load)	>0.97	
Mains Frequency	50/60Hz	
Inrush Current (I_{peak} @50%)	53A, $\Delta t < 300\mu s$	60A, $\Delta t < 300\mu s$
Total Harmonic Distortion (230Vac, full load)	$\leq 3\%$	
IP Rating	IP66	
Weight (std)	22Kg	23Kg
Dimensions	See previous pages for line diagrams	
ATEX and IECEx and UKEX Rating	See page 6	

Inrush Current Typical Curve

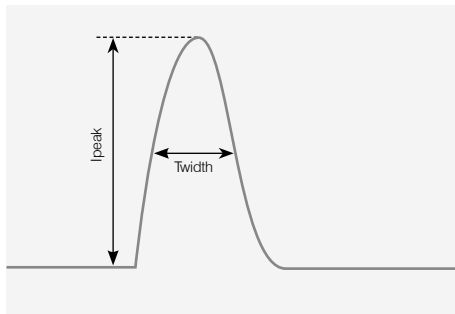

Max number of fittings allowed per MCB

MCB Type	Rating	SPZ/SPX-HP10K (120W Version)	SPZ/SPX-HP15K (180W Version)	SPZ/SPX-HP20K (240W Version)	SPZ/SPX-HP25K (300W Version)
B	10A	4	3	2	1
B	16A	10	6	4	3
B	20A	12	7	5	4
B	25A	15	10	7	6
C	10A	8	5	4	3
C	16A	16	8	6	5
C	20A	20	10	8	6
C	25A	26	16	13	9

4.1 DALI Wiring Instructions

Cross section in mm ²	Maximum cable length L in m		
	25°C	50°C	75°C
0.14	31	28	26
0.50	112	102	93
0.75	168	153	140
1.00	224	204	187
1.50	300	300	281
2.00	300	300	300
2.50	300	300	300

5. Troubleshooting

1. Ensure the two LED boards are correctly wired to terminal block. Red to Red : Black to Black – paired cables
2. Ensure Mains input is correctly connected.
3. Ensure Mains Input is turned on at the source.
4. If LED panel fails to light is it possible to identify if problem is with LED panel or power supply by swapping LED cables to opposite power supply to help identify problem.

Declaration Of Conformity With The Atex Directive 2014/34/EU & UK Directive SI 2016 No. 1107 (as amended)



Raytec Ltd. declares under our sole responsibility that the product(s) listed below conform with the relevant provisions of directive 2014/34/EU of 20th April 2016 and UK Directive SI 2016 No. 1107 (as amended)

Manufacturer	Raytec Ltd Unit 15, Wansbeck Business Park Rotary Parkway Ashington Northumberland NE63 8QW United Kingdom
Description of Equipment	Spartan range of High Power Floodlights
Certification Body	CML New Port Road Ellesmere Port CH65 4LZ
Certificate numbers	CML17ATEX1148 or IEC Ex CML17.0074 or CML21UKEX1102 CML17ATEX4149 or IEC Ex CML17.0074 or CML21UKEX4101 CML18ATEX3161 or IEC Ex CML18.0087 or CML21UKEX3107 ATEX Quality Assurance Notification CSA BV (2813) UKCA Quality Assurance Notification CSA UK (0518)
Equipment Marking	II 2 GD Ex db eb mb IIB T4 Gb Ta -50°C to +50°C Ex tb IIIC T104°C Db Ta -50°C to +50°C IP66 150-264V AC/DC or 110-254V AC/DC II 3 GD Ex nR ec IIC Gc Ta -50°C to +50°C Ex tc IIIC T104°C Dc Ta -50°C to +50°C IP66 150-264V AC/DC or 110-254V AC/DC Ex tb IIIC T104°C Db Ta -50°C to +50°C IP66 150-264V AC/DC or 110-254V AC/DC

Compliance with the Essential Health and Safety Requirements has been assessed by reference to the following harmonised/designated standards -

EN 60079-0 : 2018 EN 60079-1 : 2014 EN60079-7 : 2015 + A1 2018

EN 60079-15 : 2019 EN 60079-18 : 2015 + A1 2017 EN60079-31 : 2014

And also 2014/35/EU - Low Voltage Directive, 2014/30/EU - EMC Directive

Signed



Name
Position

Barry Thompson
Director

Dated

Serial number



#05-34, Ubi Techpark (Lobby B), 10 Ubi Crescent, Singapore 408564

Tel. +65 6814 9717 +65 6025 3019

sales@fseprojects.com

www.fsesafe.com / www.fse-exdigital.com

Source: <https://www.rayteclcd.com/>